

# COB LED FIXE

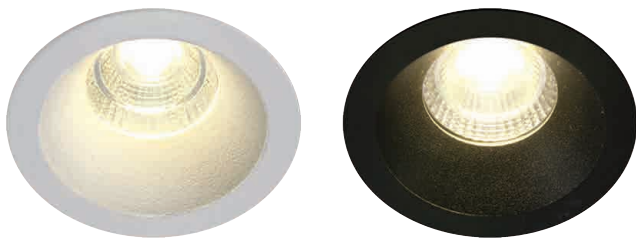

Collerette aluminium  
Module LED en retrait, Faisceau 50°  
Driver 300mA ON/OFF  
IRC > 80

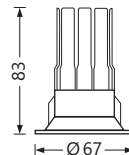

Code article	Watt	Teinte LED	Flux utile/50°	Finition	Tarif € HT
<a href="#">1-L-10107DC/W/W</a>	7W	3000K	560lm	Blanc	NC
<a href="#">1-L-10107DC/B/W</a>				Noir	

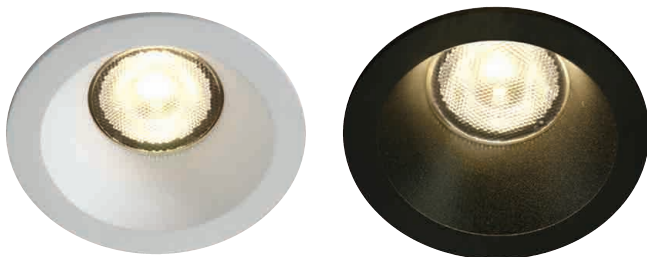

Collerette aluminium  
Module LED en retrait, Faisceau 38°  
Driver 700mA ON/OFF  
IRC > 90  
Version gradable TRIAC disponible

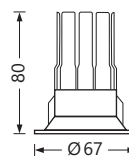

Code article	Watt	Teinte LED	Flux utile/38°	Finition	Tarif € HT
<a href="#">1-L-10107WP/W/W</a>	6,5W	3000K	550lm	Blanc	NC
<a href="#">1-L-10107WP/B/W</a>				Noir	

# COB LED SEMI-ENCASTRÉ



[1-L-10112R/B/W](#)



Corps aluminium,  
Pose encastrée ou  
Pose semi-encastrée avec bague aluminium,  
Faisceau 50°  
Driver 700mA ON/OFF  
IRC > 80  
Version gradable TRIAC disponible



[1-L-10112R/B/W](#)  
+  
[1-L-050162/W](#)



[1-L-050162/W](#)



[1-L-050162/B](#)



[1-L-050162/DC](#)



[1-L-050162/GL](#)

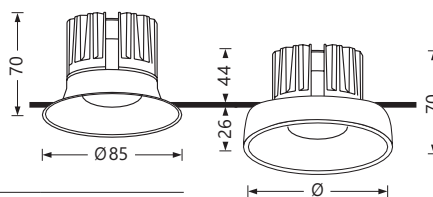

Code article	Watt	Teinte LED	Flux utile/35°	Finition	Tarif € HT
<a href="#">1-L-10112R/B/W</a>	12W	3000K	1100lm	Corps Noir	NC

Bague

<a href="#">1-L-050162/X</a>	X = W (Blanc), B (Noir), DC (Chrome foncé), GL (Or)				NC
------------------------------	---	--	--	--	----

# COB LED FIXE DÉCOR



1-L-10107K/W/W  
+  
1-L-050104/B



1-L-10107K/B/W  
+  
1-L-050104/BS



1-L-050104/W



1-L-050104/B



1-L-050104/C



1-L-050104/BS



1-L-050104/CU



Colerette aluminium  
Réflecteur PMMA interchangeable  
Faisceau 35°  
Driver 700mA ON/OFF  
IRC > 80  
Version gradable TRIAC disponible

Code article	Watt	Teinte LED	Flux utile /35°	Finition	Tarif € HT
1-L-10107K/W/W	6,5W	3000K	550lm	Corps Blanc	NC
1-L-10107K/B/W				Corps Noir	
Réflecteur					
1-L-050104/X	X = W (Blanc), B (Noir), C (Chrome), BS (Laiton), CU (Cuivre)				NC

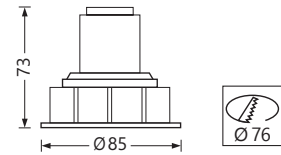

# COB LED ORIENTABLE

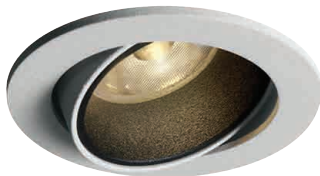

1-L-11107K/W/W  
+  
1-L-050102/B



1-L-11107K/B/W  
+  
1-L-050102/BS



1-L-050102/W



1-L-050102/B



1-L-050102/C



1-L-050102/BS



1-L-050102/CU



Colerette aluminium  
Réflecteur PMMA interchangeable  
Faisceau 35°  
Driver 700mA ON/OFF  
IRC > 80  
Version gradable TRIAC disponible

Code article	Watt	Teinte LED	Flux utile /35°	Finition	Tarif € HT
1-L-11107K/W/W	6,5W	3000K	550lm	Corps Blanc	NC
1-L-11107K/B/W				Corps Noir	
Réflecteur					
1-L-050102/X	X = W (Blanc), B (Noir), C (Chrome), BS (Laiton), CU (Cuivre)				NC

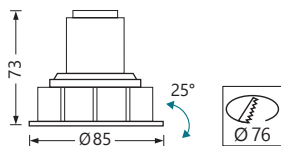

# POLO IP



Corps en fonderie aluminium, blanc  
Réflecteur faisceau 36° et lentille prismatique anti-éblouissement  
Driver inclus  
40000h/L70/B10 - Garantie 3 ans  
IRC > 80, SDCM 3  
Bornier classe II de repiquage disponible

Code article	Watt	Teinte LED	Flux utile /36°	Design	Tarif € HT
<a href="#">POL-FIP103630-10</a> <a href="#">POL-FIP103640-10</a>	10W	3000K 4000K	940lm 1000lm	Fixe	NC
<a href="#">POL-BIP103630-10</a> <a href="#">POL-BIP103640-10</a>	10W	3000K 4000K	940lm 1000lm	Basculant	NC

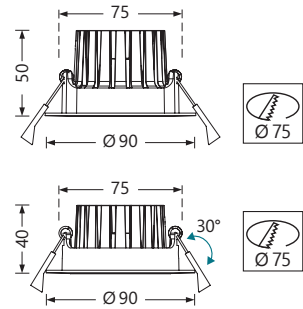

# LULA



N/L-9580621

N/L-9580626

N/L-9580625

N/L-9580624



Corps et collerette aluminium  
Module LED en retrait, Faisceau 38°  
Driver 300mA ON/OFF  
50000h/L80/B10  
IRC > 90, UGR < 19, SDCM 3  
Version gradable disponible

Code article	Watt	Teinte LED	Flux utile /38°	Finition	Tarif € HT
<a href="#">N/L-9580621</a> <a href="#">N/L-9580626</a>	12W	3000K	1039lm	Blanc/Blanc	NC
Noir/Blanc					
Blanc/Noir					
Blanc/Doré					
Noir/Doré					
<a href="#">N/L-9580625</a> <a href="#">N/L-9580624</a> <a href="#">N/L-9580623</a> <a href="#">N/L-9580622</a>			967lm	Noir/Noir	

