

Luminaires sur mâts

**CIRCULAR** by **CREE**   
 Gamme URBAN SERIES

**Lanterne ligne épurée, environnements urbains**  
**Montage sur bras latéral ou en tête de mât**

**Corps en fonderie aluminium**  
**Peinture poudre époxy haute résistance, finition noir**

**Technologie LED haute performance**

**Choix de 9 optiques pour une adaptation parfaite**  
**aux différentes configurations**  
**Module LED 45w, avec possibilité de réduction**  
**de puissance**  
**Lentilles de précision NanoOptique®**  
**Câble 50cm avec connecteur rapide**

**200 000h/L80/B10 - Garantie 5 ans**  
**IRC > 70 - SDCM < 4**

**Sur demande :**

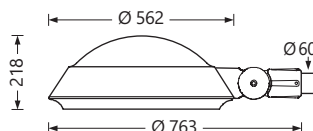

- Finition ivoire, bronze antique, gris ou vert sapin
- Version suspendue ou sur caténaire
- Version gradable
- Constant Lumen Output (CLO)

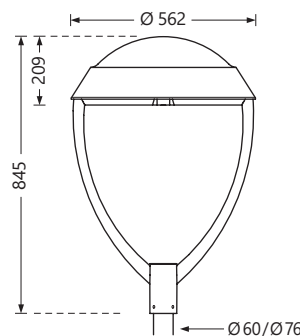

Bras latéral



Tête de mât

Code article	Puissance	Optique*	Classe	Montage	Tarif € HT
<b>CREE UCREF#xx1BK</b>	45w	<b>2LG</b> Type II Long		Bras latéral	NC
<b>CREE UCREF#xx2BK</b>		<b>275</b> Type II Short 0,75			
		<b>210</b> Type II Short 1,0			
		<b>2SH</b> Type II Short			
<b>CREE UCREF#xx1BK</b>	45w	<b>3SH</b> Type III Short		Tête de mât	NC
<b>CREE UCREF#xx2BK</b>		<b>3ME</b> Type III Medium			
		<b>4ME</b> Type IV Medium			
		<b>5ME</b> Type V Medium			
		<b>5SH</b> Type V Short			
<b>OPTIONS</b>	Réduction de puissance 19w/27w/29w/34w/38w/43w				NC
	Abaissement de puissance 50%, Minuit virtuel				NC

xx = **30** (3000K), **40** (4000K) ou **57** (5700K)

\*Optique à préciser (cf page 240)

Luminaires sur mâts

Gamme  
URBAN SERIES by **CREE**

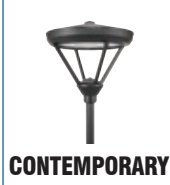

**Optiques** / Valeurs pour Ta 25°C  
Hauteur 6m

**2LG / Type II Long**

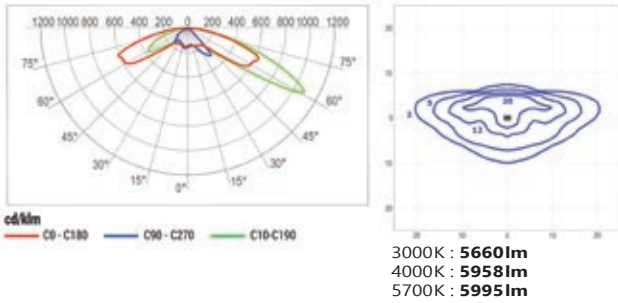

**275 / Type II Short 0,75**

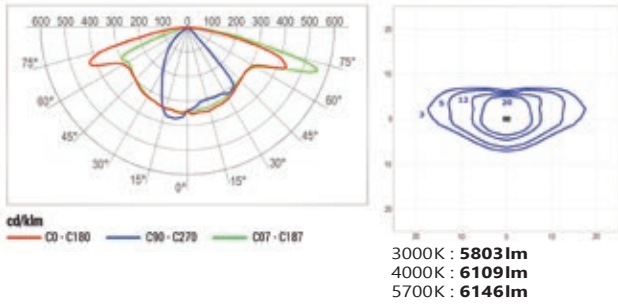

**210 / Type II Short 1,0**

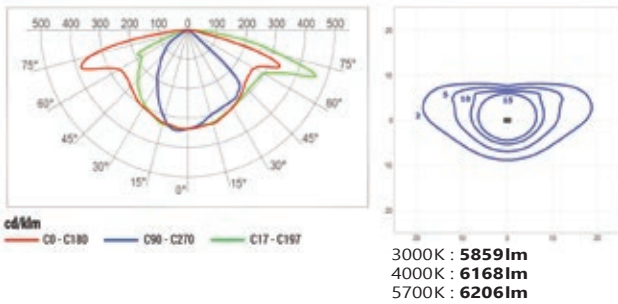

**2SH / Type II Short**

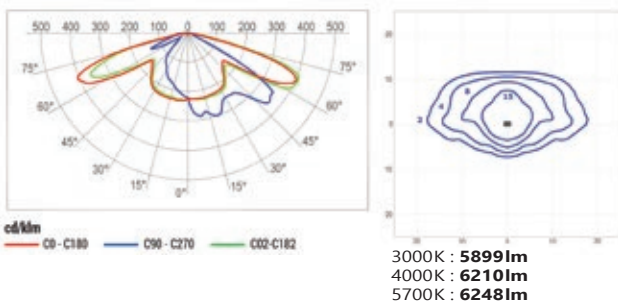

**3SH / Type III Short**

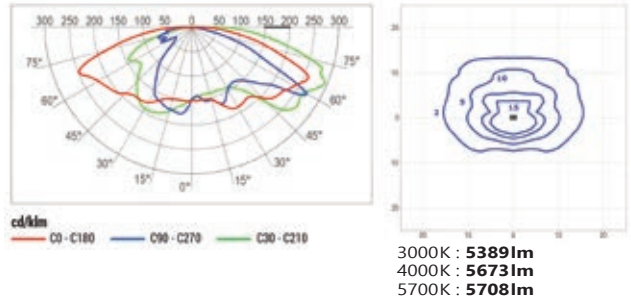

**3ME / Type III Medium**

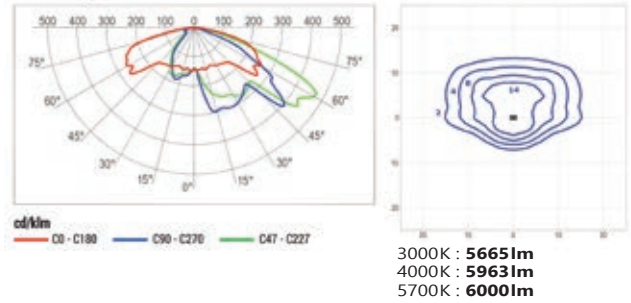

**4ME / Type IV Medium**

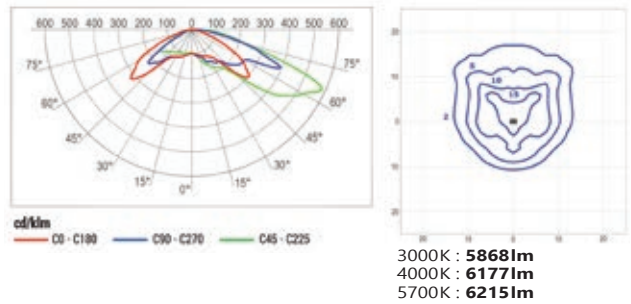

**5ME / Type V Medium**

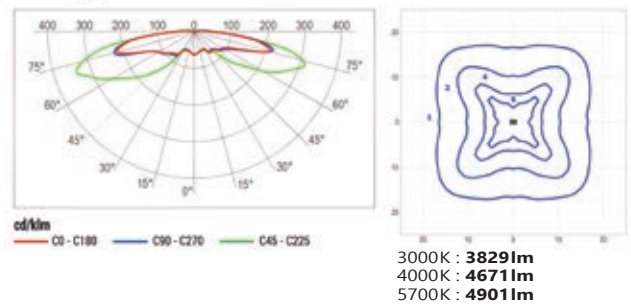

**5SH / Type V Medium**

